

TECHNOFORM

# Standard profiles 2025

Insulation solutions for  
windows, doors, and facades.



# Standard profiles for windows, doors, and facades

## Find your perfect match – our standard profile solutions

Our standard offering comprises more than 800 freely available geometries for varying markets and needs. High quality solutions can be created using the insulating profiles in the standard program. All serial products can be rapidly supplied in any length and quantity to any location in the world, thanks to our global network of 13 production sites and more than 45 sales offices. Our specialists will gladly assist you with your project from the planning and development stage up to the finished product.



## Low Lambda Polyamide – thermal break has a new value

On the path towards an optimized Uf value, we have also developed a new standard: our Low Lambda Polyamide. With this innovation we can now offer you two possibilities to match your requirements. Choose between a reduced Uf value by maintaining the same frame size or a smaller frame while leaving the Uf value unchanged.



The material and information contained in this catalogue are for general information only. Technoform offers you advice concerning any doubts or queries before making commercial decisions based on the information in this catalogue. Technoform changes design and functionality of certain products through continuous innovations and improvements. Thus, Technoform reserves the right to change descriptions any time and discontinue or withdraw any particular product during the year of validity of this catalogue, without any prior notice. Technoform declines any responsibility for any possible inadvertently caused inaccuracies or omissions in this catalogue and the consequences that these may cause.

# Our materials - always rely on the best

When it comes to our materials, you can be assured that we are only satisfied with the best. Thus, we offer a major material variety to find the perfectly tailored solutions for every project. High precision for processing, compatibility, environmentally friendly production and best mechanical performance are just some of the characteristics you can rely on.

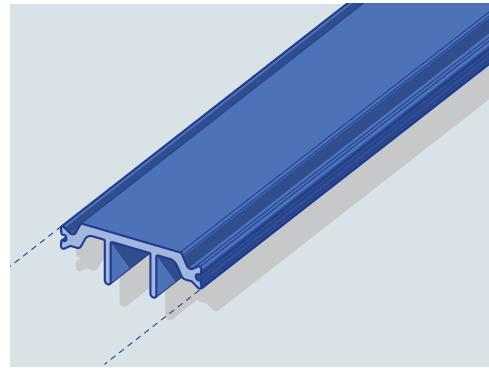

## **Standard Polyamide / PA 66 GF25, dry impact resistant**

With our standard polyamide-based material we guarantee unlimited availability and recyclability as well as excellent performance to match your needs.

## **Low Lambda Polyamide**

With our innovative Low Lambda polyamide-based material you get a certified and reliable Lambda value of  $0.21 \text{ W/(mK)}^*$  and with it the best all around solution.

\*  $0.198 \text{ W/(mK)}$  under ASTM C518-17, Standard Test Method for Steady-State Thermal Transmission Properties by Means of the Heat Flow Meter Apparatus

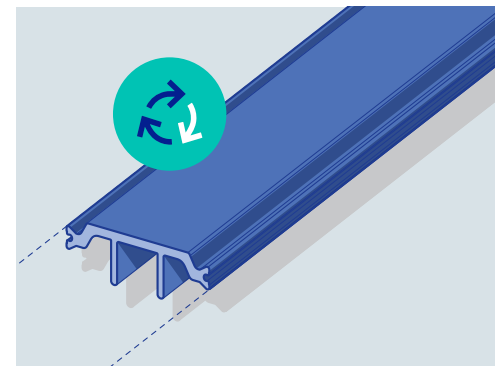
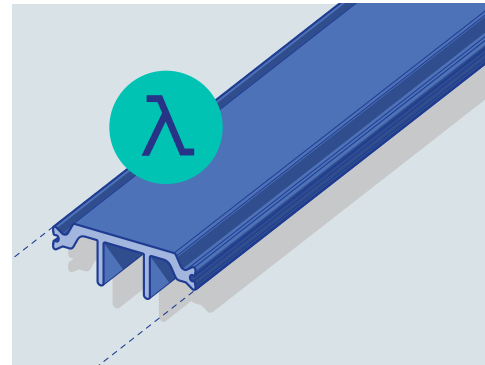

## **Recycled Polyamide**

To take a step further in the increased use of eco-friendly materials, we offer recycled polyamide-based material that fulfills our high quality and processing standards. This includes both Standard PA 66 GF25 and Low Lambda options, ensuring a versatile range of sustainable solutions tailored to your needs.

















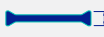











































# Low Lambda, the new standard

# Standard profiles Low Lambda Polyamide

Our profiles are extruded in Low Lambda PA 66 GF25, dry impact resistant.

000000 Article Number / 000000 New Article /

\*Article production in America or Asia / #Head not compatible to Standard Groove



































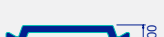













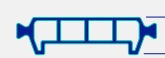











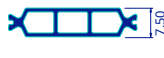







| 12 mm   | 16 mm   | 20 mm   | 22 mm   | 23 mm   | 24 mm   | 24 mm   | 26 mm   | 27 mm   | 28 mm   | 29 mm   |   |
|---|---|---|---|---|---|---|---|---|---|---|---|
| <br>839200 | <br>855400 | <br>824300   | <br>817700 | <br>833100 | <br>842400   | <br>853400   | <br>829200   | <br>824200 | <br>854800   | <br>863800 | <br>815200 |
|   | <br>856000 | <br>835200   | <br>847500 |   | <br>853300   | <br>828200   | <b>24.8 mm</b>  | <br>859700 | <br>809700   | <br>824100 |   |
|   |   | <br>830600   | <br>842300 |   | <br>804100   | <br>848600   | <br>855300   |   | <br>806100   | <br>824000 |   |
|   |   | <br>834600   | <br>818000 |   | <br>828300   | <br>852900   | <br>857600   |   | <br>850300   |   |   |
|   |   | <br>842700   |   |   | <br>833800   | <br>804200   | <br>855200   |   | <br>803300   |   |   |
|   |   | <br>845700 |   |   | <br>842200 | <br>811000 | <br>858800 |   | <br>805900 |   |   |
|   |   | <br>829300 |   |   | <br>866000 | <br>854700 | <br>863700 |   | <br>850400 |   |   |
|   |   |   |   |   | <br>829400 | <br>858500 | <br>857500 |   | <br>809600 |   |   |
|   |   |   |   |   | <br>813900 | <br>858400 |   |   | <br>803200 |   |   |
|   |   |   |   |   | <br>847700 | <br>850800 |   |   | <br>859800 |   |   |
|   |   |   |   |   | <br>854100 | <br>845600 |   |   |   |   |   |
|   |   |   |   |   | <br>834000 | <br>847600 |   |   |   |   |   |

# Standard profiles Low Lambda Polyamide

Our profiles are extruded in Low Lambda PA 66 GF25, dry impact resistant.





















000000 Article Number / **000000 New Article** /

\*Article production in America or Asia / #Head not compatible to Standard Groove

| 30 mm   | 32 mm   | 34 mm   | 35 mm   | 36 mm  | 37 mm   | 38 mm   | 39 mm   | 40 mm   |   |   |   |
|---|---|---|---|--|---|---|---|---|---|---|---|
| <br>846500   | <br>823600   | <br>821100   | <br>838700   | <br>830100 | <br>816900 | <br>809900 | <br>829900   | <br>863900 | <br>810800 | <br>823400 | <br>841900 |
| <br>800200   | <br>861700   | <br>807600   | <br>831400   | <br>861300 | <br>840200 | <br>813700 | <br>843600   | <br>827300 | <br>805000 | <br>806400 |   |
| <br>809800   | <br>803000   | <br>849100   | <br>802800   | <br>821000 | <br>851600 | <br>808000 | <br>801600   | <br>800800 | <br>865600 |   |   |
| <br>860000   | <br>851700   | <br>802200   | <br>838600   | <br>846300 |   |   | <br>842000   | <br>848200 |   |   |   |
| <br>803100   | <br>857900   | <br>855100   | <br>857800  |  |   |   | <br>827200   |   |   |   |   |
| <br>806300 | <br>800900 | <br>813300 | <br>866100 |  |   |   | <br>805100 |   |   |   |   |
|   | <br>833300 | <br>811800 | <br>811500 |  |   |   | <br>801500 |   |   |   |   |
|   | <br>811800 | <br>813200 | <br>825300 |  |   |   | <br>842100 |   |   |   |   |
|   | <br>823800 | <br>833200 | <br>838500 |  |   |   | <br>821300 |   |   |   |   |
|   | <br>833200 | <br>862200 | <br>849200 |  |   |   | <br>827100 |   |   |   |   |
|   | <br>835300 |   |   |  |   |   | <br>855500 |   |   |   |   |
|   |   |   |   |  |   |   | <br>801400 |   |   |   |   |







# Standard profiles Low Lambda Polyamide





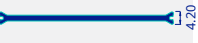
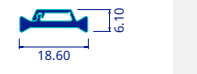

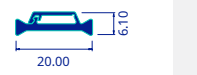
Our profiles are extruded in Low Lambda PA 66 GF25, dry impact resistant.

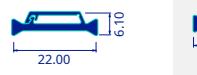
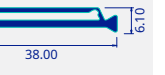
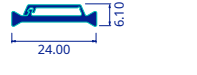
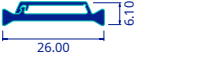
| 42 mm   | 44 mm  | 45 mm  | 46 mm  | 48 mm   | 50 mm  |
|---|--|--|--|---|--|
|  806800   |  810700 |  808100 |  852600 |  861900 |  812800 |
|  862500   |  863500 |  |  |   |  854000 |
|  849900   |  863600 |  |  |   |  |
|  845400   |  |  |  |   |  |
|  862400   |  |  |  |   |  |
|  840000 |  |  |  |   |  |
|  840100 |  |  |  |   |  |
|  835700 |  |  |  |   |  |
|  835600 |  |  |  |   |  |
|  839900 |  |  |  |   |  |
|  849800 |  |  |  |   |  |
|  862600 |  |  |  |   |  |

000000 Article Number / 000000 New Article /

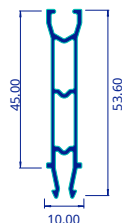
\*Article production in America or Asia / #Head not compatible to Standard Groove

| 54 mm  | 55 mm  | 58 mm  | 60 mm  | Anti bi-metal  |  |
|--|--|--|--|--|--|
|  812600 |  833500 |  862000 |  862100 |  835800 |  810000 |
|  812500 |  |  |  |  850900 |  824600 |
|  822900 |  |  |  |  835900 |  850200 |
|  |  |  |  |  835400 |  |
|  |  |  |  |  851000 |  |

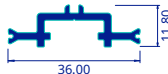
| Profiles for sliding doors   | Hidden sash  | Curtain wall spacers   |
|--|--|--|
|  863000 |  859600 |  860900 |
|  863400 |  864000 |  |
|  851800 |  |  |
|  862300 |  |  |
|  843500 |  |  |

# Our principle: we optimize your processes and you have more time for the important things

Insulation for aluminum windows, doors, and facades can always be optimized and improved to hit peak performance. Our specialized processing methods can streamline your workflow and leave you to focus on the rest.

## Glue wire

If you need to add extra steps to your production process, we know that this can be a drain on time and money. Adding glue wire to a profile reduces the loss of shear strength due to powder coating, and we can pre-install it for you, meaning no extra processes or added headaches on your end.

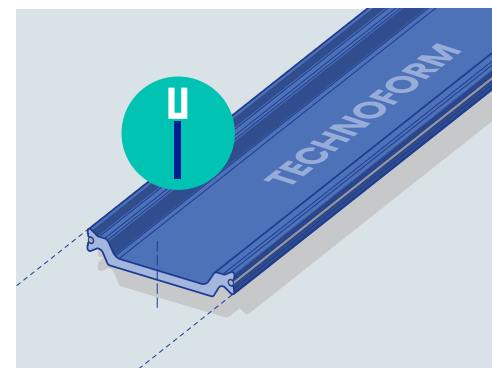
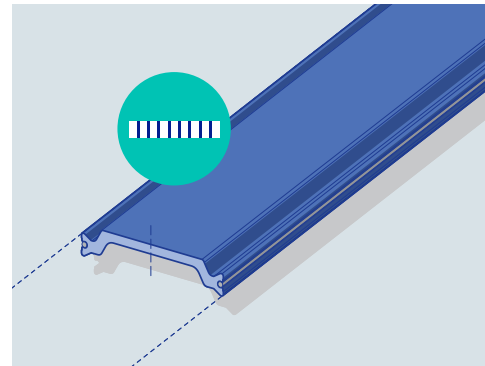

## Lasermarking

Sometimes it's little touches that add quality and functionality to a product. By having your profiles lasermarked, you can increase your brand visibility, adding value to your products, or simply make them easier to trace for improved logistics and quality control.

## Adhesive film

Maintaining the visual appearance of a smoothly produced profile presents a different aesthetic challenge. Supplying profiles with an adhesive film already applied protects them during the coating process, and means they remain looking as smooth and high-quality as they did when they left the plant.

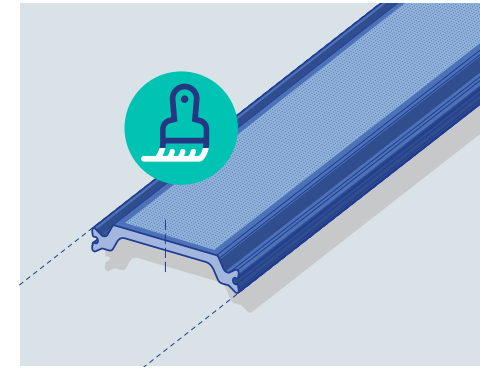
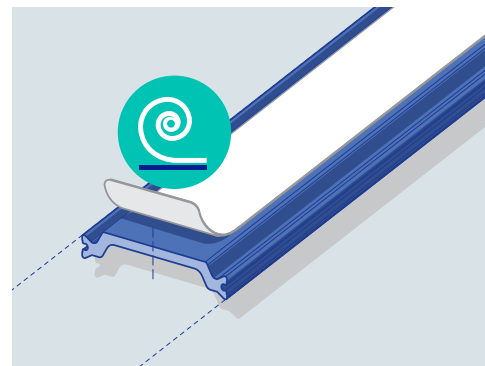

## Coating Prime

Achieve an excellent surface finish in polyamide coating by optimizing powder paint deposition while maintaining the low thermal conductivity of polyamide.

Coating Prime enhances paint adhesion to polyamide, increases the attraction of powder paint, and reduces bubble formation during the curing process.

# Your challenge is our motivation

## Solutions for sliding windows and doors

Sliding windows and doors are popular in modern architecture for their aesthetic appeal and functionality. Achieving thermal optimization, visual minimalism, and smooth mechanical operation requires precise manufacturing. Technoform profiles are crafted with tight tolerances, exact geometry, and smooth surfaces for friction-free movement.

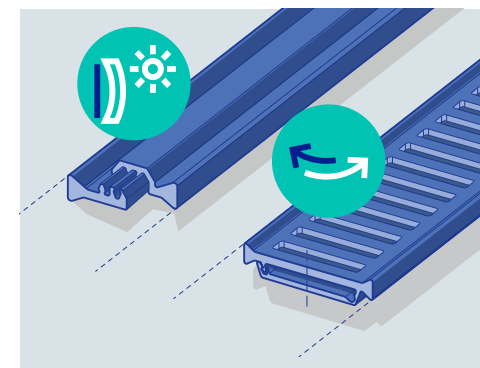
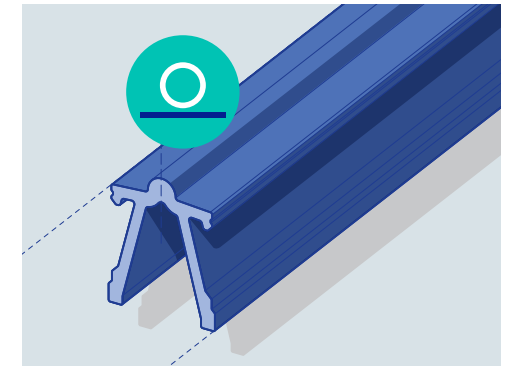

## Anti bi-metal

The so-called bi-metallic effect occurs when there is a large difference in temperature between the inner and outer frame of a door. The outer frame expands and can cause distortion of the door and locking difficulties. Our solution allows the outer frame to expand with only minimum effect to the fit of the inner frame, meaning it continues to function as normal.

## Drainage

French NF DTU 39 P1-1 regulation stipulates that windows must have drainage holes for water to filter through the profiles. By supplying profiles with drainage holes means that fabricators do not need to drill these holes themselves, thereby adding value to the product they sell.

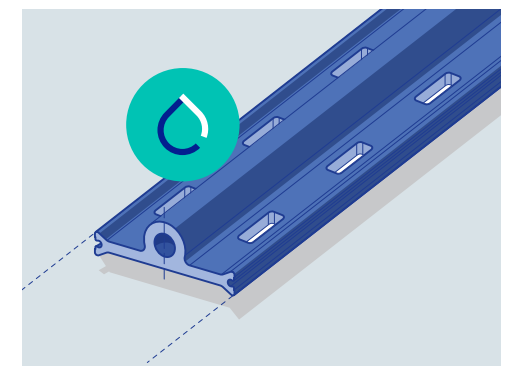

# Adhesion Prime - the ultimate solution for Polyamide-to-Material bonding

The bonding of components in aluminum windows with thermal break is a critical process for system manufacturers, designers, and installers, demanding precision and reliability. To address this challenge, Technoform has introduced Adhesion Prime, an innovative and patented solution designed to significantly enhance the adhesion properties of polyamide. This breakthrough ensures a superior bond between the adhesive and the substrates.

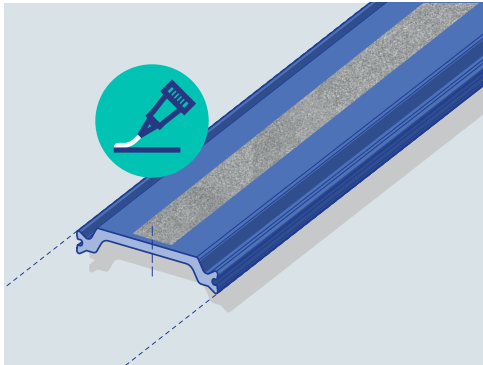

### New possibilities

The ability to achieve optimal adhesion between polyamide and the substrate significantly expands design options for systems and structural solutions, enabling innovations that were previously beyond our reach.

### Unitized curtain walls

Adhesion Prime allows sealing the glazing unit with silicone from the edge to an adjacent element, usually aluminum.

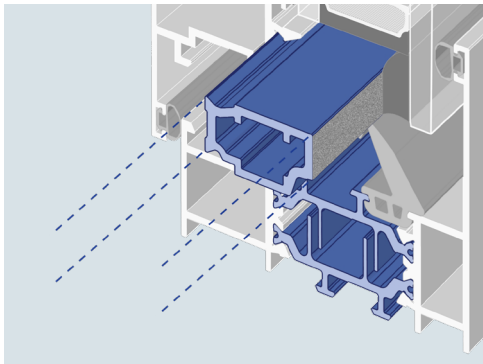
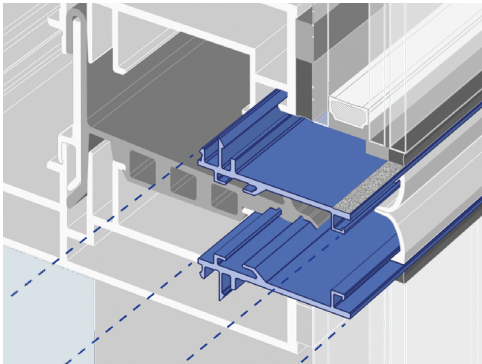

### Hidden sash

Adhesion Prime enables bonding between the glazing and the sash profile through polyamide strips, achieving a more seamless integration between the glazing and the frame. This innovation eliminates the need for external glazing beads and joints on the sash, streamlining the design. Additionally, it enhances the rigidity of the sash, providing improved structural stability and performance.

### Minimalist sash of sliding system

Designed with a minimal frame to maximize transparency, these systems emphasize a clean, elegant aesthetic. However, the polyamide profile, crucial for superior thermal performance, can pose challenges in bonding with other materials. To overcome this, Adhesion Prime enables polyamide to bond with glazing as effectively as aluminum, creating a durable assembly that glides effortlessly along the frame's rail.

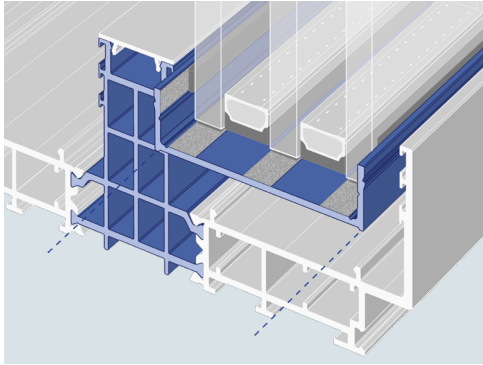

## Endless possibilities

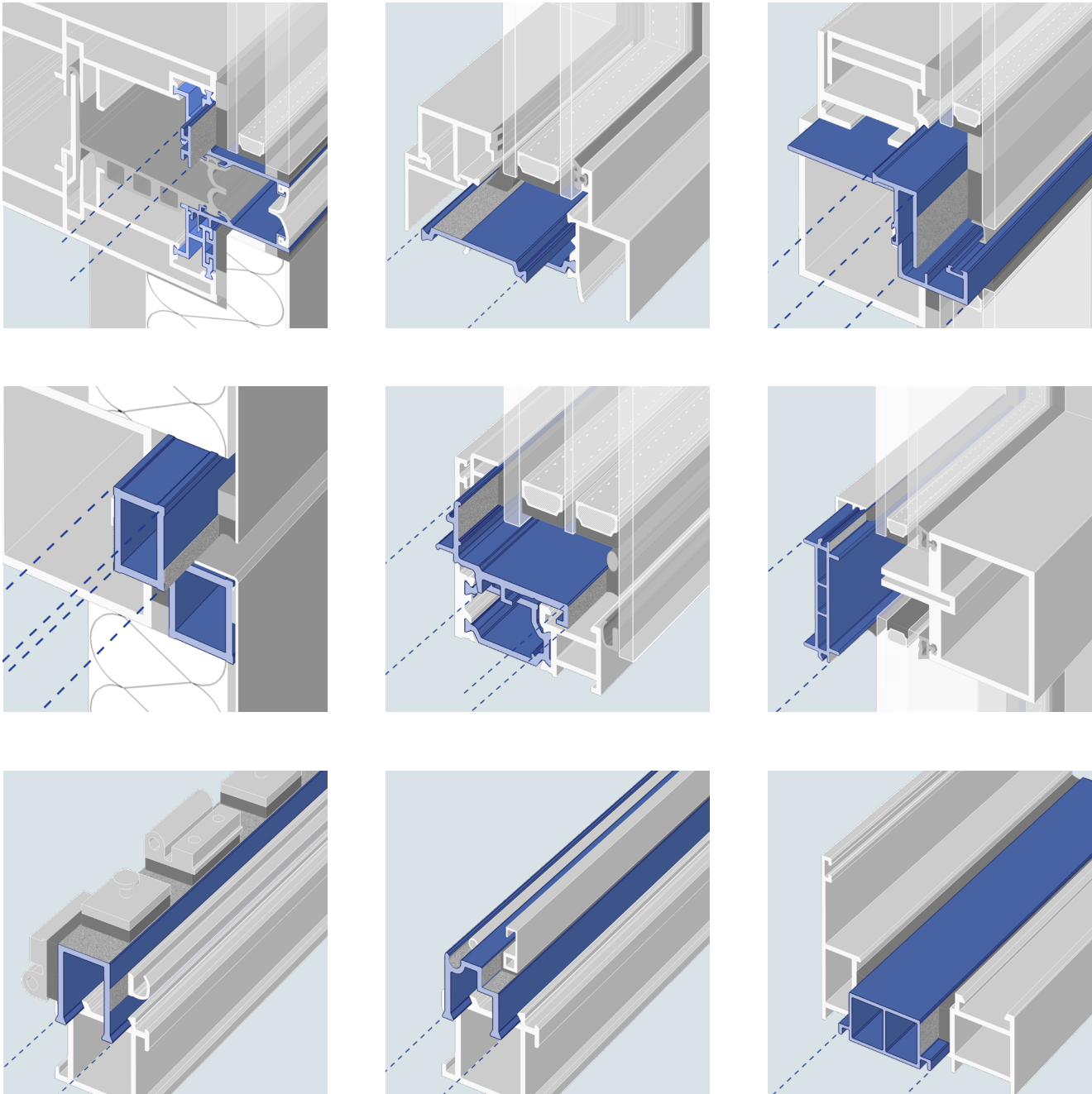



# Facade solutions – boosting intelligence in modern buildings

Lightweight, durable, stylish: when it comes to the exteriors of office buildings and other large-scale construction projects, aluminum is frequently the material of choice. Aside from the visual aspects we take a step further to a more intelligent construction. Our aluminum facade solutions for external wall insulation help improve the thermal performance of this popular material. And we do it for a reason. Just relax and let us optimize your facades for full peace of mind.

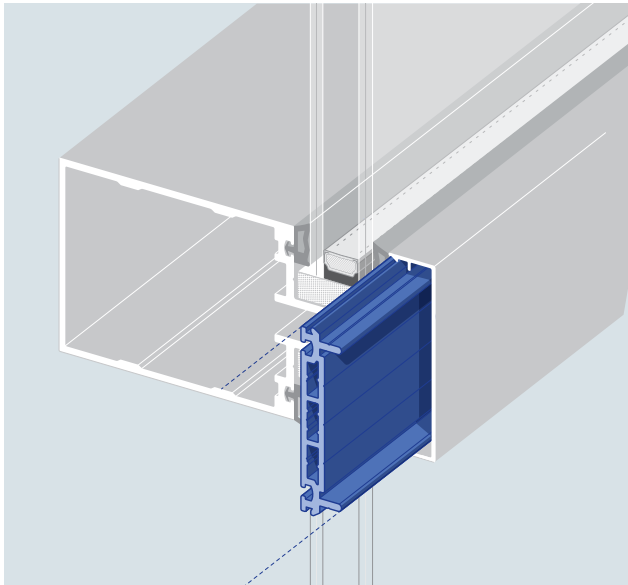

### Stick facades

For stick-facades, we offer a variety of 20 different standard polyamide spacers and pressure plates. To be more precise: our system solutions offer best in class thermal performance with U-values as low as 1 W/(m<sup>2</sup>K).

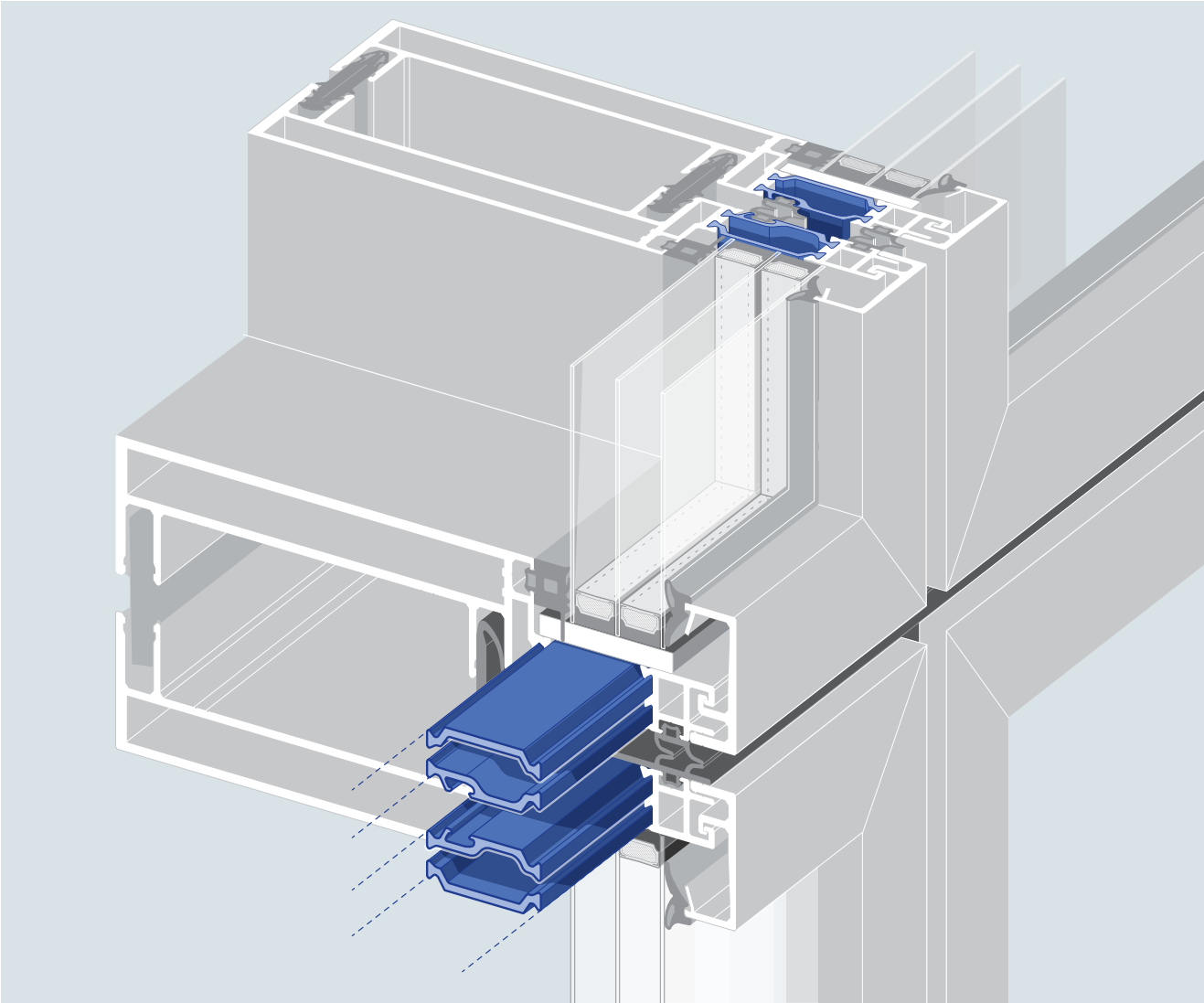
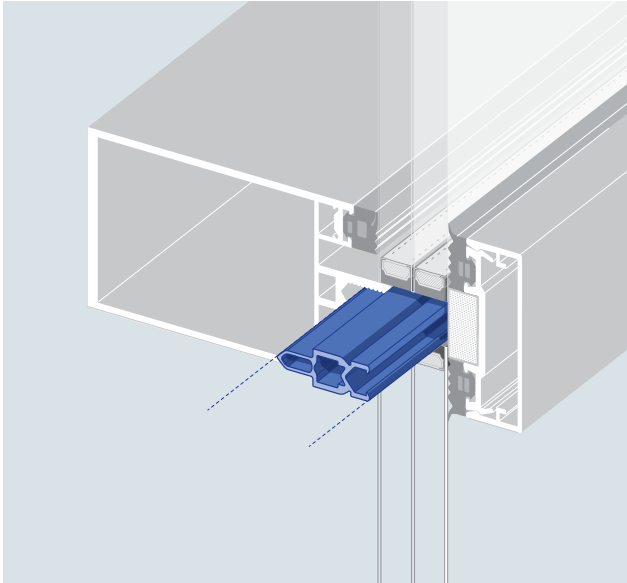

### Unitized facades

All our insulating solutions for windows are suitable for unitized facades and we have special polyamide glass edge profiles for new systems.

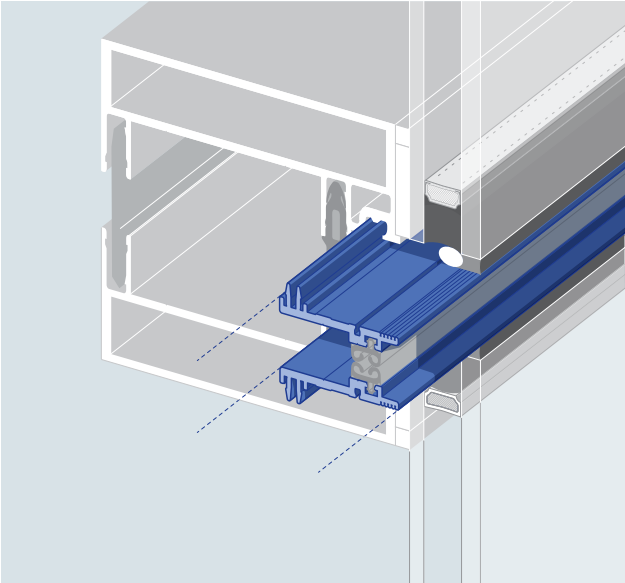



































# Standard profiles PA66 GF25

000000 Article Number / 000000 New Article /

\*Article production in America or Asia / #Head not compatible to Standard Groove

| 9 mm  | 10 mm  | 12 mm  | 13 mm   | 14 mm  |  |
|---|--|--|---|--|--|
| <br>254000 | <br>204600# | <br>977500          | <b>13.4 mm</b>  | <br>202300    | <b>14.3 mm</b>   |
|   | <br>244800  | <br>926900 · 975300 | <br>979200 | <br>913700    | <br>246900            |
|   | <br>269800# | <br>209900          | <b>13.5 mm</b>  | <br>202400    | <br>247000            |
|   |  | <br>328100          | <br>249100 | <br>217100    | <b>14.6 mm</b>   |
|   |  | <br>958241          | <br>969505 | <br>233200    | <br>933900 · 951459   |
|   |  | <br>282000        |   | <br>948600  | <br>919200 · 951159 |
|   |  | <br>442500*       |   | <br>493100# | <br>263400          |
|   |  |  |   | <br>486900  | <br>259900#         |
|   |  |  |   | <br>948700  | <br>951559 · 943300 |
|   |  |  |   | <br>235300  | <br>241600          |
|   |  |  |   | <br>240200# | <br>980600          |
|   |  |  |   |  | <br>268200          |



# Standard profiles Polyamide

Our standard profiles are available in Standard and Recycled PA 66 GF25, dry impact resistant.

| 14 mm  |  |  | 15 mm   |   |   |
|--|--|--|---|---|---|
| 14.6 mm  | 14.8 mm  |  |   |   |   |
| <br>355700* | <br>371700                      | <br>937600            | <br>221900   | <br>335600#   | <br>910300 |
| <br>223900  | <br>280600                      | <br>295600#           | <br>403400   | <br>320100*  | <br>538500 |
| <br>313000* | <br>931000 · 951659             | <br>299000            | <br>221400   | <br>257100   | <br>260500 |
|  | <br>216800                      | <br>486100*           | <br>237600   | <br>270300   | <br>260400 |
|  | <br>271800                    | <br>201000          | <br>246700 | <br>937700 |   |
|  | <br>924300 · 945500<br>951259 | <br>931100 · 951759 | <br>300800 | <br>488200 |   |
|  | <br>203900                    | <br>941600 · 951859 | <br>271500 | <br>977000 |   |
|  | <br>208500                    | <br>961459          | <br>273500 |   |   |
|  | <br>952100 · 962059           | <br>925500          | <br>289700 |   |   |
|  | <br>406100#                   | <br>975800          | <br>961559 |   |   |
|  | <br>378600                    | <br>279000          | <br>987400 |   |   |





























000000 Article Number / 000000 New Article /

\*Article production in America or Asia / #Head not compatible to Standard Groove

| 16 mm  |   |   | 17 mm   | 18 mm   |   |
|--|---|---|---|---|---|
| <br>379100                    | <br>940800   | <br>977600   | <br>296800     | <br>589200   | <br>955100   |
| <br>962159#                   | <br>976000   | <br>445500   | <br>296700     | <br>592000   | <br>908300   |
| <br>973500                    | <br>296500   | <br>977900   | <b>16.5 mm</b>  | <br>286600#  | <br>221200   |
| <br>232900 · 265800           | <br>277600*# | <br>940300   | <br>977400     | <b>17.4 mm</b>  | <br>249200   |
| <br>912000 · 955900<br>951359 | <br>962259#  | <br>981700   | <b>16.6 mm</b>  | <br>242700#  | <br>964000   |
| <br>345800#                 | <br>970559 | <br>296600 | <br>420800*# | <b>17.8 mm</b>  | <br>465400 |
| <br>221000                  | <br>973600 | <br>980900 |   | <br>330400 | <br>233800 |
| <br>961859                  | <br>942100 | <br>214400 |   | <br>325300 | <br>270200 |
| <br>963900                  | <br>976100 | <br>221100 |   |   | <br>955000 |
| <br>203200#                 | <br>265900 | <br>227500 |   |   | <br>622800 |
| <br>219900                  | <br>941800 | <br>270100 |   |   | <br>541400 |
| <br>270000                  | <br>961959 | <br>296900 |   |   | <br>267100 |













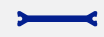





















# Standard profiles Polyamide

Our standard profiles are available in Standard and Recycled PA 66 GF25, dry impact resistant.

| 18 mm  | 19 mm  | 20 mm   |
|--|--|---|
| <br>276900    | <b>18.6 mm</b>   | <br>316700   |
| <br>224100    | <br>210900          | <br>276000   |
| <br>290600    | <br>273300          | <br>250800   |
| <br>357400*   | <br>912100 · 912159 | <br>979300   |
| <br>955200    | <br>912800          | <br>330500   |
| <br>277000  | <br>977700        | <br>952459 |
| <br>343900  | <br>279300*       |   |
| <br>235400  | <br>332700*       |   |
| <br>322100* | <br>360500*       |   |
| <br>248300  | <br>276800        |   |
| <br>955300  | <br>324600        |   |
|  | <br>226300        |   |

000000 Article Number / 000000 New Article /





































































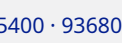

\*Article production in America or Asia / #Head not compatible to Standard Groove

| 20 mm  | 21 mm   | 22 mm  | 23 mm  |
|--|---|--|--|
| <br>964200    | <br>250000   | <br>556500    | <br>202200    |
| <br>271100    | <br>439500*# | <br>357500*   | <br>242900    |
| <br>966500    | <b>20.6 mm</b>  | <br>556400    | <br>908400    |
| <br>306700    | <br>221500#  | <br>269700    | <br>286700    |
| <br>325500    | <br>221600#  | <br>966605    | <br>389600    |
| <br>283600  |   | <br>978700  | <br>245800  |
| <br>493600  |   | <br>413700  | <br>491600  |
| <br>297800* |   | <br>228100  | <br>439100* |
| <br>924900  |   | <br>271300* |  |
| <br>964100  |   | <br>243000  |  |
| <br>271200  |   | <br>431300  |  |
| <br>330700  |   | <br>245900  |  |

# Standard profiles Polyamide

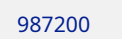
Our standard profiles are available in Standard and Recycled PA 66 GF25, dry impact resistant.













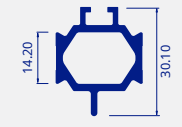







## 24 mm

|  |  |  |   |   |  |
|--|--|--|---|---|--|
| <br>961759 · 933100 | <br>268000            | <br>220300    | <br>360900   | <br>224000   | <br>419300    |
| <br>965159#         | <br>294100            | <br>246300*   | <br>566000   | <br>251800   | <br>359800    |
| <br>919300 · 975900 | <br>976700            | <br>271400*   | <br>322000   | <br>969759   | <br>546100    |
| <br>390900          | <br>940400            | <br>927200    | <br>495000   | <br>246600   | <br>443700    |
| <br>241700#         | <br>969959            | <br>925200    | <br>403500   | <br>289800   | <br>256800    |
| <br>956059        | <br>479800          | <br>975700  | <br>249000 | <br>464600 | <br>273400  |
| <br>957500        | <br>984300          | <br>404000* | <br>231900 | <br>479700 | <br>464700  |
| <br>350300        | <br>961105          | <br>228200  | <br>268100 | <br>502900 | <br>516200  |
| <br>355000        | <br>979500          | <br>415100  | <br>294200 | <br>330600 | <br>510600  |
| <br>360800        | <br>459500          | <br>956159  | <br>964300 | <br>228800 | <br>418200  |
| <br>954800        | <br>975400 · 936800 | <br>291100  | <br>400800 | <br>300400 | <br>406200# |
| <br>235100        | <br>987200          | <br>253600  | <br>979900 | <br>561400 | <br>399200  |







000000 Article Number / 000000 New Article /

\*Article production in America or Asia / #Head not compatible to Standard Groove





















## 24 mm

|  |   |
|--|---|
| <br>231800    | <br>578400   |
| <br>358900    | <br>964559#  |
| <br>297200    |   |
| <br>297100    | <b>24.8 mm</b>  |
| <br>214000    | <br>215600   |
| <br>489900  | <br>246100 |
| <br>969859  | <br>215700 |
| <br>962659  | <br>265000 |
| <br>214800  | <br>214300 |
| <br>224600  | <br>282100 |
| <br>413900  | <br>246000 |
| <br>439400# |   |

## 25 mm

|   |   |
|---|---|
| <br>910400   | <b>25.3 mm</b>  |
| <br>979400   | <br>470200*  |
| <br>950159   | <br>329600*  |
| <br>974500   | <br>329700*  |
| <br>249500  | <br>329800* |
| <br>946700 | <b>25.5 mm</b>  |
| <br>249600 | <br>220400 |
| <br>974600 |   |
| <br>249700 |   |

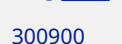
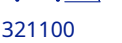
## 26 mm





























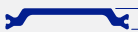

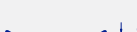



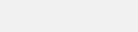

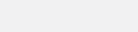

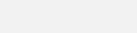

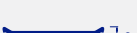

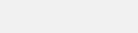

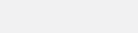
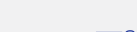



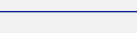
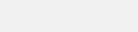

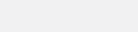

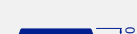





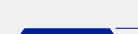
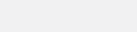

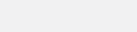

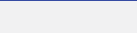
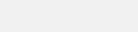

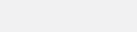

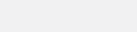

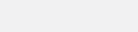

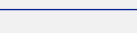

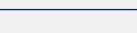

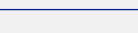



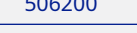



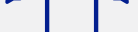

|  |   |
|--|---|
| <br>212600    | <br>410800   |
| <br>254800    | <br>401700   |
| <br>908500    | <br>321800   |
| <br>260600    | <br>978900   |
| <br>453100   | <br>426400  |
| <br>304500  | <br>359600 |
| <br>491200  | <br>394200 |
| <br>289300# | <br>208700 |
| <br>978800  | <br>264100 |
| <br>357700  | <br>300900 |
| <br>321100  |   |
| <br>544900  |   |

# Standard profiles Polyamide

Our standard profiles are available in Standard and Recycled PA 66 GF25, dry impact resistant.





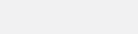













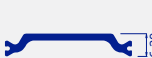

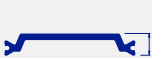



































000000 Article Number / 000000 New Article /

\*Article production in America or Asia / #Head not compatible to Standard Groove

| 27 mm  | 28 mm  |   | 29 mm  | 30 mm  | 30 mm   |  | 31 mm   | 32 mm  |  | 34 mm  |
|--|--|---|--|--|---|--|---|--|--|--|
|  971605   |  222500   |  354400*   |  404600 |  286800     |  516600    |  247400     |  268300    |  239300   |  418400   |  464800   |
|  932000   |  948400   |  475500    |  |  286900     |  225500    |  364500     |   |  354700   |  256000   |  268400   |
|  253800   |  927700   |  355400    |  |  229100     |  493800    |  352400     |   |  303700   |  256300   |  349300   |
|  253900   |  618200   |  548200    |  |  308600     |  393000    |  368700     |   |  371800   |  563100   |  478700   |
| <b>27.5 mm</b>   |  214700   |  571000    |  |  261900     |  414400    |  414300     |   |  256100   |  412200   |  935100   |
|  942700 |  223500 |  321500  |  |  242100   |  324100# |  241200   |   |  494500 |  218100 |  949200 |
|  |  321300 |  566100  |  |  282300 |  493700  |  277100*# |   |  939700 |  216100 |  986200 |
|  |  516900 |  450000  |  |  947400 |  974700  |  |  259800  |  492100 |  438400 |  |
|  |  368600 |  280800  |  |  506200 |  312000  |  |  448300  |  273900 |  265400 |  |
|  |  509900 |  319600  |  |  247300 |  282400  |  |  247700# |  488300 |  384200 |  |
|  |  450100 |  271600  |  |  478600 |  364600  |  |  256200  |  |  218600 |  |
|  |  280900 |  975100* |  |  486400 |  247500  |  |  496000  |  |  269200 |  |















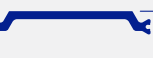

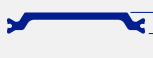

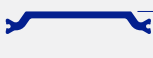

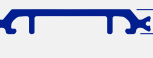
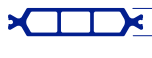

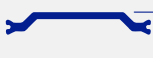

# Standard profiles Polyamide

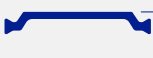
Our standard profiles are available in Standard and Recycled PA 66 GF25, dry impact resistant.

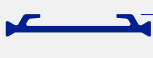
| 34 mm   |   |   | 35 mm  |   | 36 mm   |
|---|---|---|--|---|---|
| <br>425100   | <br>378200   | <br>425000   | <br>432000    | <br>418900    | <br>201300 |
| <br>429100   | <br>548300   | <br>437800   | <br>337700    | <br>423500*   | <br>983400 |
| <br>430400   | <br>429300   | <br>558600   | <br>418600    | <br>382100    | <br>557600 |
| <br>321700   | <br>437900   | <br>218400   | <br>533200    | <br>418500    | <br>392400 |
| <br>426300   | <br>422900   | <br>258800   | <br>522100    | <b>35.3 mm</b>  | <br>478100 |
| <br>986300 | <br>423300 | <br>543300 | <br>215500  | <br>485500* |   |
| <br>265600 | <br>386800 | <br>503700 | <br>358700  | <br>477400* |   |
| <br>587800 | <br>443900 | <b>34.8 mm</b>  | <br>452300  | <br>477500* |   |
| <br>532600 | <br>260900 | <br>300700 | <br>418800  |   |   |
| <br>357000 | <br>240800 | <br>300600 | <br>423700* |   |   |
| <br>377100 | <br>400100 |   | <br>427100  |   |   |
| <br>559400 | <br>265500 |   | <br>418700  |   |   |









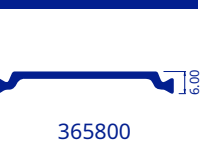

000000 Article Number / 000000 New Article /

\*Article production in America or Asia / #Head not compatible to Standard Groove

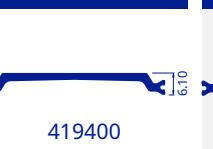
| 37 mm  | 38 mm   | 39 mm   | 40 mm   | 42 mm   | 44 mm   |
|--|---|---|---|---|---|
| <br>394600* | <br>327800 | <br>357900   | <br>357800   | <br>286300 | <br>502100 |
| <br>425200  | <br>219300 | <br>340000   | <br>444200   | <br>334800 | <br>352100 |
| <br>515000  | <br>363700 | <br>340300   | <br>287800   | <br>599100 | <br>501000 |
| <br>394400* |   | <br>340200   | <br>412000   |   |   |
| <br>394500* |   | <br>546200   | <br>521000   |   |   |
|  |   | <br>452100 | <br>442800 |   |   |
|  |   | <br>340100 | <br>441900 |   |   |
|  |   | <br>368500 | <br>364700 |   |   |

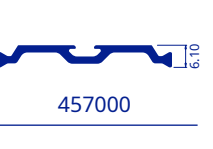
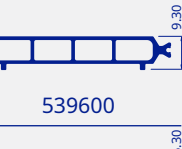
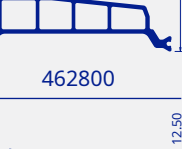

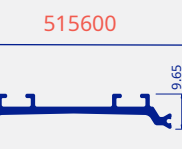
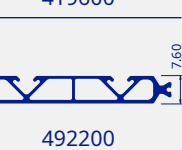
# Standard profiles Polyamide

Our standard profiles are available in Standard and Recycled PA 66 GF25, dry impact resistant.

| 45 mm  | 46 mm   | 48 mm   | 49 mm   | 50 mm  | 54 mm   |
|--|---|---|---|--|---|
| <br>466500 | <br>200100 | <br>365800 | <br>617600 | <br>419400 | <br>419500   |
|  |   | <br>457000 |   |  | <br>539600   |
|  |   |   |   |  | <br>462800   |
|  |   |   |   |  | <br>515700   |
|  |   |   |   |  | <br>515600  |
|  |   |   |   |  | <br>419600 |
|  |   |   |   |  | <br>492200 |

000000 Article Number / 000000 New Article /

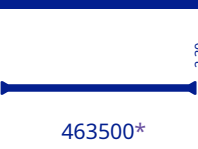
\*Article production in America or Asia / #Head not compatible to Standard Groove

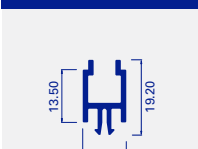
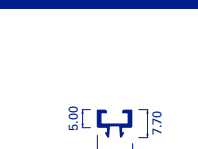
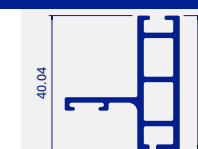
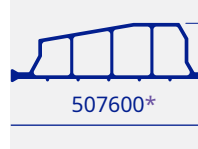
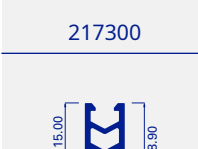
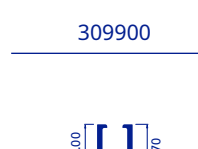
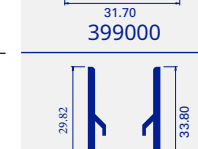
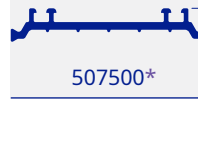
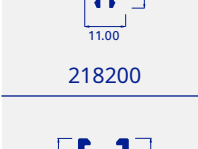
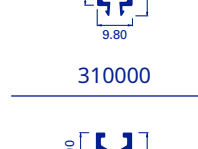
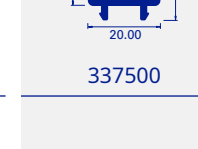
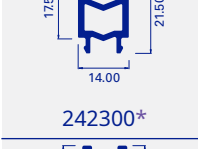
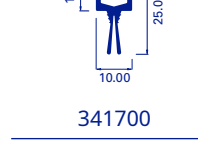
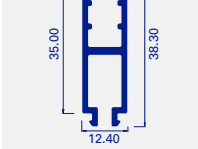
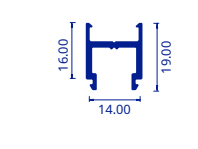
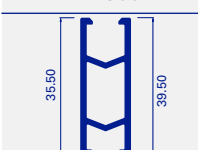
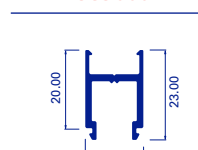
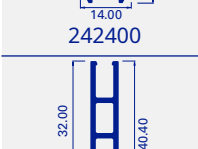
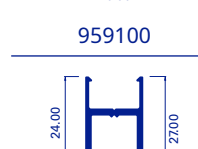
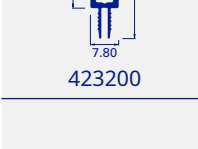
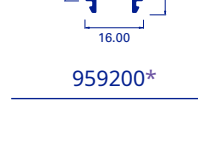
| 60 mm  | 64 mm  | 77 mm  | Curtain wall spacers   |  |   |
|--|--|--|--|--|---|
| <br>463500* | <br>328600  | <br>261000* | <br>217300    | <br>309900    | <br>399000 |
|  | <br>507600* |  | <br>218200    | <br>310000    | <br>337500 |
|  | <br>507500* |  | <br>242300*   | <br>341700    | <br>337400 |
|  |  |  | <br>212500    | <br>959000    |   |
|  |  |  | <br>242400   | <br>959100   |   |
|  |  |  | <br>423200  | <br>959200* |   |
|  |  |  | <br>248800* | <br>472500* |   |
|  |  |  | <br>280100  | <br>398900  |   |



# Standard profiles Polyamide















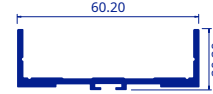

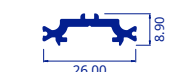





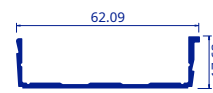



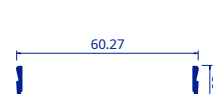



Our standard profiles are available in Standard and Recycled PA 66 GF25, dry impact resistant.

| Operating Rods   | Specials   | Hidden Sash   | Anti bi-metal   |   |   |
|--|--|---|---|---|---|
| <br>224400    | <br>200600    | <br>346000   | <br>458800   | <br>339000    | <br>576000   |
| <br>222400    | <br>212100    | <br>620400   | <br>317000   | <br>464400    | <br>605100   |
| <br>218000    | <br>254400    | <br>375400   | <br>370000   | <br>429900    | <br>599900   |
| <br>601100  | <br>505200   | <br>464900 | <br>317100 | <br>520900  | <br>598700 |
| <br>289400* | <br>492000  | <br>529500 | <br>339900 | <br>521000  | <br>590900 |
| <br>254700  | <br>432100* | <br>506400 | <br>316200 | <br>592400 |   |
| <br>224500  | <br>491700* | <br>550600 | <br>387500 | <br>605200 |   |
|  | <br>449500* | <br>513400 | <br>418100 |   |   |

000000 Article Number / 000000 New Article /

\*Article production in America or Asia / #Head not compatible to Standard Groove

## Profiles for sliding doors

| Profiles for sliding doors  |   |  |   | Profiles for minimal sliding doors   |
|---|---|--|---|--|
| <br>200500   | <br>389900   | <br>437700    | <br>274000   | <br>440100  |
| <br>979600   | <br>486200   | <br>301000    | <br>245000   | <br>440200  |
| <br>244900   | <br>371900   | <br>618300    | <br>306200*  | <br>440300  |
| <br>343200 | <br>977100 | <br>255300  | <br>354300 | <br>440400 |
| <br>385200 | <br>933000 | <br>263000  | <br>384300 |  |
| <br>403600 | <br>385100 | <br>282200  | <br>959300 |  |
| <br>415500 | <br>306300 | <br>419000* |   |  |
| <br>311300 | <br>229000 | <br>495600  |   |  |

# Material data sheet

Insulating strips of **PA 66 GF25, dry impact resistant**

| Characteristic                          | Reference standard  | Unit              | Samples prepared from extruded insulating strips |   | Injection-moulded samples |
|---|---------------------|-------------------|--|---|---------------------------|
|   |                     |                   | Dry <sup>(1)</sup>                               | Equilibrium moisture content <sup>(2)</sup> | Dry <sup>(1)</sup>        |
| melting temperature                     | EN ISO 11357-3      | °C                | min. 250 <sup>(3)</sup>                          | min. 250 <sup>(3)</sup>                     | min. 250 <sup>(3)</sup>   |
| density                                 | EN ISO 1183-1 or -3 | g/cm <sup>3</sup> | 1.3 +/- 0.05                                     | 1.3 +/- 0.05                                | 1.3 +/- 0.05              |
| annealing residue (glass fibre content) | EN ISO 1172         | %                 | 25 +/- 2.5                                       | 25 +/- 2.5                                  | 25 +/- 2.5                |
| shore hardness D                        | EN ISO 868          | -                 | 82 +/- 4 <sup>(4)</sup>                          | 78 +/- 4 <sup>(4)</sup>                     | 84 +/- 2                  |
| impact strength                         | EN ISO 179-1        | kJ/m <sup>2</sup> | min. 30 or without break <sup>(5)</sup>          | min. 40 or without break <sup>(5)</sup>     | min. 35 <sup>(6)</sup>    |
| tensile strength                        | EN ISO 527-2 and -4 | N/mm <sup>2</sup> | min. 80 <sup>(7)</sup>                           | min. 50 <sup>(7)</sup>                      | min. 110 <sup>(8)</sup>   |
| Young's modulus                         | EN ISO 527-2 and -4 | N/mm <sup>2</sup> | min. 4500 <sup>(7)</sup>                         | min. 2000 <sup>(7)</sup>                    | min. 6000 <sup>(8)</sup>  |
| elongation at break                     | EN ISO 527-2 and -4 | %                 | min. 3 <sup>(7)</sup>                            | min. 7 <sup>(7)</sup>                       | min. 3 <sup>(8)</sup>     |

- <sup>1)</sup> Sample water content less than 0.2 % by weight
- <sup>2)</sup> Fast conditioning acc. to EN ISO 1110 (23 °C / 50 %)
- <sup>3)</sup> Maximum temperature 300 °C
- <sup>4)</sup> Specimen thickness 2 mm, unstacked
- <sup>5)</sup> Specimen 2fU (50 mm x 10 mm x 2 mm)
- <sup>6)</sup> Specimen 1fU (80 mm x 10 mm x 4 mm)
- <sup>7)</sup> Specimen Type 1BA
- <sup>8)</sup> Specimen Type 1A

In case of specific questions we gladly offer you our individual support.

# Material data sheet

Insulating strips of **Low Lambda PA 66 GF25, dry impact resistant**

| Characteristic                          | Reference standard  | Unit              | Samples prepared from extruded insulating strips |   |
|---|---------------------|-------------------|--|---|
|   |                     |                   | Dry <sup>(1)</sup>                               | Equilibrium moisture content <sup>(2)</sup> |
| melting temperature                     | EN ISO 11357-3      | °C                | min. 250 <sup>(3)</sup>                          | min. 250 <sup>(3)</sup>                     |
| density                                 | EN ISO 1183-1 or -3 | g/cm <sup>3</sup> | 1.0 +/- 0.1                                      | 1.0 +/- 0.1                                 |
| annealing residue (glass fibre content) | EN ISO 1172         | %                 | 25 +/- 2.5                                       | 25 +/- 2.5                                  |
| shore hardness D                        | EN ISO 868          | -                 | 77 +/- 4 <sup>(4)</sup>                          | 67 +/- 4 <sup>(4)</sup>                     |
| impact strength                         | EN ISO 179-1        | kJ/m <sup>2</sup> | min. 20 <sup>(5)</sup>                           | min. 30 <sup>(5)</sup>                      |
| tensile strength                        | EN ISO 527-2 and -4 | N/mm <sup>2</sup> | min. 50 <sup>(6)</sup>                           | min. 35 <sup>(6)</sup>                      |
| Young's modulus                         | EN ISO 527-2 and -4 | N/mm <sup>2</sup> | min. 2900 <sup>(6)</sup>                         | min. 1300 <sup>(6)</sup>                    |
| elongation at break                     | EN ISO 527-2 and -4 | %                 | min. 3 <sup>(6)</sup>                            | min. 8 <sup>(6)</sup>                       |

- <sup>1)</sup> Sample water content less than 0.2 % by weight
- <sup>2)</sup> Fast conditioning acc. to EN ISO 1110 (23 °C / 50 %)
- <sup>3)</sup> Maximum temperature 300 °C
- <sup>4)</sup> Specimen thickness 2 mm, unstacked
- <sup>5)</sup> Specimen 2fU (50 mm x 10 mm x 2 mm)
- <sup>6)</sup> Specimen Type 1BA

In case of specific questions we gladly offer you our individual support.

# Material data sheet

Insulating strips of **Recycled PA 66 GF25**, dry impact resistant



| Characteristic                          | Reference standard  | Unit              | Samples prepared from extruded insulating strips |   | Injection-moulded samples |
|---|---------------------|-------------------|--|---|---------------------------|
|   |                     |                   | Dry <sup>(1)</sup>                               | Equilibrium moisture content <sup>(2)</sup> | Dry <sup>(1)</sup>        |
| melting temperature                     | EN ISO 11357-3      | °C                | min. 250 <sup>(3)</sup>                          | min. 250 <sup>(3)</sup>                     | min. 250 <sup>(3)</sup>   |
| density                                 | EN ISO 1183-1 or -3 | g/cm <sup>3</sup> | 1.3 +/- 0.05                                     | 1.3 +/- 0.05                                | 1.3 +/- 0.05              |
| annealing residue (glass fibre content) | EN ISO 1172         | %                 | 25 +/- 2.5                                       | 25 +/- 2.5                                  | 25 +/- 2.5                |
| shore hardness D                        | EN ISO 868          | -                 | 82 +/- 4 <sup>(4)</sup>                          | 78 +/- 4 <sup>(4)</sup>                     | 84 +/- 2                  |
| impact strength                         | EN ISO 179-1        | kJ/m <sup>2</sup> | min. 30 or without break <sup>(5)</sup>          | min. 40 or without break <sup>(5)</sup>     | min. 35 <sup>(6)</sup>    |
| tensile strength                        | EN ISO 527-2 and -4 | N/mm <sup>2</sup> | min. 80 <sup>(7)</sup>                           | min. 50 <sup>(7)</sup>                      | min. 110 <sup>(8)</sup>   |
| Young's modulus                         | EN ISO 527-2 and -4 | N/mm <sup>2</sup> | min. 4500 <sup>(7)</sup>                         | min. 2000 <sup>(7)</sup>                    | min. 6000 <sup>(8)</sup>  |
| elongation at break                     | EN ISO 527-2 and -4 | %                 | min. 3 <sup>(7)</sup>                            | min. 7 <sup>(7)</sup>                       | min. 3 <sup>(8)</sup>     |

- <sup>1)</sup> Sample water content less than 0.2 % by weight
- <sup>2)</sup> Fast conditioning acc. to EN ISO 1110 (23 °C / 50 %)
- <sup>3)</sup> Maximum temperature 300 °C
- <sup>4)</sup> Specimen thickness 2 mm, unstacked
- <sup>5)</sup> Specimen 2fU (50 mm x 10 mm x 2 mm)
- <sup>6)</sup> Specimen 1fU (80 mm x 10 mm x 4 mm)
- <sup>7)</sup> Specimen Type 1BA
- <sup>8)</sup> Specimen Type 1A
- <sup>9)</sup> The polyamide 66 used consists of 100% post industrial recycled materials.

In case of specific questions we gladly offer you our individual support.

# Material data sheet

Insulating strips of **Recycled Low Lambda PA 66 GF25**, dry impact resistant



| Characteristic                          | Reference standard  | Unit              | Samples prepared from extruded insulating strips |   |
|---|---------------------|-------------------|--|---|
|   |                     |                   | Dry <sup>(1)</sup>                               | Equilibrium moisture content <sup>(2)</sup> |
| melting temperature                     | EN ISO 11357-3      | °C                | min. 250 <sup>(3)</sup>                          | min. 250 <sup>(3)</sup>                     |
| density                                 | EN ISO 1183-1 or -3 | g/cm <sup>3</sup> | 1.0 +/- 0.1                                      | 1.0 +/- 0.1                                 |
| annealing residue (glass fibre content) | EN ISO 1172         | %                 | 25 +/- 2.5                                       | 25 +/- 2.5                                  |
| shore hardness D                        | EN ISO 868          | -                 | 77 +/- 4 <sup>(4)</sup>                          | 67 +/- 4 <sup>(4)</sup>                     |
| impact strength                         | EN ISO 179-1        | kJ/m <sup>2</sup> | min. 20 <sup>(5)</sup>                           | min. 30 <sup>(5)</sup>                      |
| tensile strength                        | EN ISO 527-2 and -4 | N/mm <sup>2</sup> | min. 50 <sup>(6)</sup>                           | min. 35 <sup>(6)</sup>                      |
| Young's modulus                         | EN ISO 527-2 and -4 | N/mm <sup>2</sup> | min. 2900 <sup>(6)</sup>                         | min. 1300 <sup>(6)</sup>                    |
| elongation at break                     | EN ISO 527-2 and -4 | %                 | min. 3 <sup>(6)</sup>                            | min. 8 <sup>(6)</sup>                       |

- <sup>1)</sup> Sample water content less than 0.2 % by weight
- <sup>2)</sup> Fast conditioning acc. to EN ISO 1110 (23 °C / 50 %)
- <sup>3)</sup> Maximum temperature 300 °C
- <sup>4)</sup> Specimen thickness 2 mm, unstacked
- <sup>5)</sup> Specimen 2fU (50 mm x 10 mm x 2 mm)
- <sup>6)</sup> Specimen Type 1BA
- <sup>7)</sup> The polyamide 66 used consists of 100% post industrial recycled materials.

In case of specific questions we gladly offer you our individual support.

# Cooperation partners

## Europe

- Federation of European Window and Curtain Wall Manufacturers' Associations

## Belgium & Netherlands

- BUtgb vzw · UBAtc asbl · Belgian Union for Technical Approval in Construction
- FAC · Federatie Aluminium Constructeurs
- VMRG · Vereniging van Metalen Ramen - en Gevefabrikanten

## France

- CSTB · Centre Scientifique et Technique du Bâtiment
- SNFA · Syndicat National de la Construction des Fenêtres, Façades et Activités Associées

## Germany

- IFT-Rosenheim · Institut für Fenstertechnik e. V.
- FIW-München · Forschungsinstitut für Wärmeschutz e. V.
- IFZ · Informationszentrum Fenster Türen Fassaden e. V.
- VFF · Verband der Fenster- und Fassadenhersteller
- Bundesdeutscher Arbeitskreis für Umweltbewusstes Management (B.A.U.M.) e. V.
- A/U/F Aluminium und Umwelt im Fenster- und Fassadenbau
- EPEA Internationale Umweltforschung GmbH
- Deutsche Gesellschaft für Nachhaltiges Bauen

## Great Britain

- CAB · Council for Aluminium in Building
- BFRC · British Fenestration Rating Council

## Italy

- UNICMI · Unione nazionale delle Industrie delle Costruzioni Metalliche dell'Involucro e dei serramenti
- AITAL / QUALITAL · Associazione Italiana Trattamenti superficiali Alluminio / Organismo di Certificazione

## Portugal

- ANFAJE · Associação Nacional dos Fabricantes de Janelas Eficientes
- APAL · Associação Portuguesa Do Alumínio

## Spain

- AEA · Asociación Española del Aluminio y Tratamientos de Superficie
- ASEFAVE · Asociación Española de Fabricantes de Fachadas Ligeras y Ventanas
- Tecnalía Research & Innovation
- ENSATEC · Laboratorio de Ensayos Tecnológicos

## The Americas

### North America

- FGIA · Fenestration and Glazing Industry Alliance
- AEC · Aluminum Extruders Council
- NGA · National Glass Association
- NFRC · National Fenestration Rating Council
- FTI · Façade Tectonics Institute

### South America

- CAIAMA · Cámara Argentina de la Industria del Aluminio y Metales Afines.
- Brasil AFEAL · Associação Nacional de Fabricantes de Esquadrias de Alumínio.
- AMEVEC · Asociación Mexicana de Ventanas y Cerramientos

## Asia

### China

- CAIGA · China Architectural and Industrial Glass Assn.
- CCMCA · China Construction Metal Structure Assn.
- Hong Kong Facade Association
- National Committee of Standardization for Non-ferrous Metals

### Korea

- KAFA · Korea Architectural Facade Association

### Singapore

- SGBC · Singapore Green Building Council
- BCA · Building and Construction Authority of Singapore
- ESI · Energy Studies Institute – National University of Singapore

## Australasia

### Australia & New Zealand

- WGANZ · Window & Glass Association New Zealand
- AGWA · Australian Glass & Window Association
- IGMA · Insulating Glass Manufacturers Alliance

## Certifications



### Europe

**TÜV Certification**  
according to ISO 9001:2015  
**Cradle to Cradle Certified®**  
Gold level Material Health Certificate  
Environmental Product Declaration

### Germany

**TÜV Certification**  
according to  
ISO 14001:2015  
ISO 50001:2018  
ISO 45001:2018

### Italy

**TÜV Certification**  
according to  
ISO 14021:2018  
ISO 14021:2021  
**RINA Certification**  
according to ISO 45001

### Belgium

**ATG Certification**

### North America

**TÜV Certification**  
according to ISO 9001:2015

### Russia

**GOST Certification**  
**Cradle to Cradle Certified™**  
Gold level Material Health Certificate

### China

**TÜV Certification**  
according to  
ISO 14001:2015  
ISO 9001:2015  
ISO 45001:2018

### Hong Kong

**TÜV Certification**  
according to  
ISO 14001:2015  
ISO 9001:2015  
ISO 45001:2018

### Singapore

**Singapore Green Building Product – Excellent**

# Closer than you may think – you find us all over the world.



## Europe

**Balkans** c/o Milan office  
Telephone: +39 02 9375 721

**Belgium** Tournai  
Telephone: +32 10 396 900

**France** Lyon  
Telephone: +33 762 047301

**Germany** Kassel  
Telephone: +49 561 9583400

Kassel  
Telephone: +49 561 207530

**Great Britain** Alcester  
Telephone: +44 1789 761323

**Greece** c/o Milan office  
Telephone: +39 02 9375 721

**Italy** Milan  
Telephone: +39 02 9375 721

**Spain** Barcelona  
Telephone: +34 932 386 438

Tordesillas  
Telephone: +34 983 796 632

**Turkey** c/o Milan office  
Telephone: +39 02 9375 721

## The Americas

**North America** Twinsburg, OH  
Telephone: +1 330 4876600 Telephone: Linqu +86 139 5240 2431

McMinnville, OR  
Telephone: +1 971 8320502 Telephone: Hangzhou +86 139 1311 0144

Kingsport, TN  
Telephone: +1 423 2021812 Telephone: Xi'an +86 139 6219 3080

**South America** São Paulo  
Telephone: +55 1196573 7527 Telephone: Tianjin +86 186 2214 2389

Argentina  
Telephone: +54 911 4565 5758 Telephone: Mumbai +91 96 19333880

**Japan** Tokyo  
Telephone: +81 3 55799454

**China** Suzhou  
Telephone: +86 512 62833188 Telephone: Seoul +82 2 5017357

Beijing  
Telephone: +86 010 65907177 Telephone: **Middle East** Dubai, UAE +971 4 3215615

Shenzhen  
Telephone: +86 755 26727912 Telephone: **Singapore** Singapore +65 62739595

Shanghai  
Telephone: +86 21 62611991 Telephone: **Taiwan** Taipei +86 150 1251 6795

Shenyang  
Telephone: +86 24 23963791

Hong Kong  
Telephone: +852 2665 6322 Telephone: **Australasia**

Chengdu  
Telephone: +86 28 84397818 Telephone: **Australia** Melbourne +61 3 88445582

**New Zealand** Auckland +64 9415 9050

**TECHNOFORM**

[www.technoform.com](http://www.technoform.com)